



Modern Washer

⚠️ WARNING

Small parts and sharp points may be present prior to assembly.

Adult assembly required.
For ages 3 and up.

Cleaning:
This unit can be cleaned with a mild soap and water solution. Be sure to wipe all water from the wood surface.

Important:
Do not discard these instructions.
Keep this copy in a safe place.

Assembly Note:
To ease assembly, do not fully tighten screws during assembly process. After until is fully assembled, go back and tighten all screws.

Will need a Phillips Screw Head for some assembly.

HARDWARE

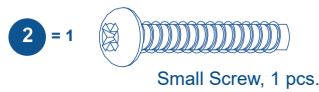
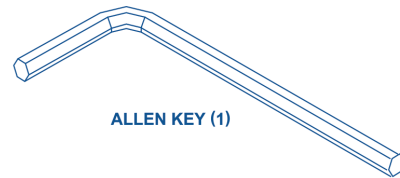

PARTS LIST

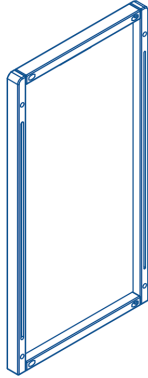

A = 1



B = 1

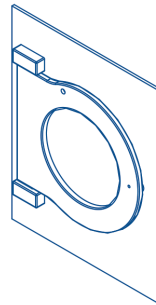

E = 1

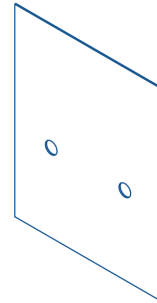

F = 1

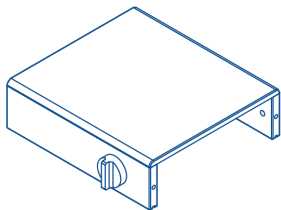

C = 1

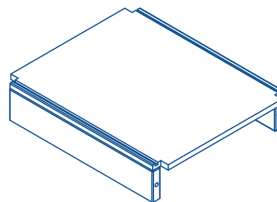

D = 1



G = 1

ASSEMBLY DIAGRAM

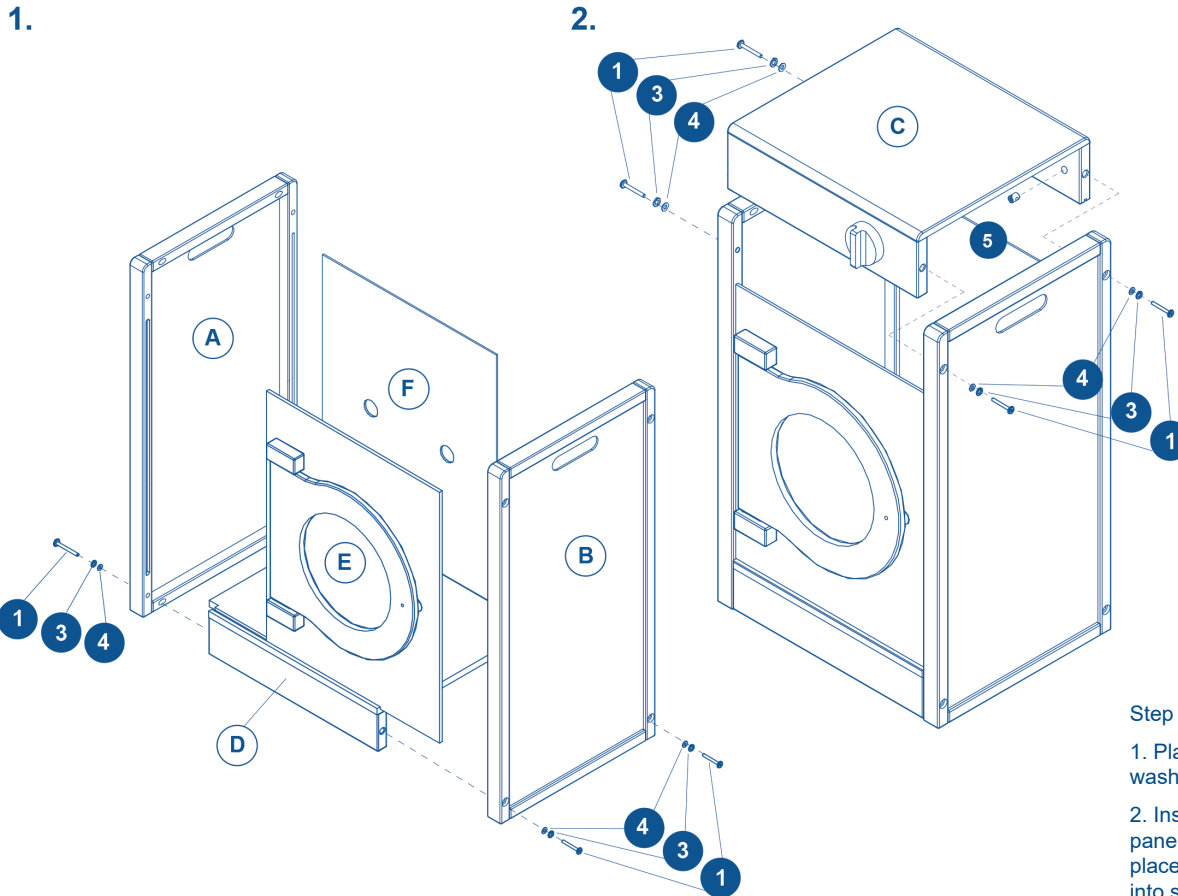

Step 1

1. Place flat washer (4) and lock washer (3) on large screw.
2. Insert nutsert (5) into bottom panel (D). Hold nutsert (5) into place as you insert large screw (1) into side panel (A).
3. Follow Step 2. Keep some space to slide front panel (E) and back panel (F) into place.

Step 2

4. Before placing washer top (C), add nutsert (5).
5. Place washer top (C) into place. Pieces will all fit together. Insert large screw (1) into top panel (C).

Step 3

6. Add door knob (G) using small screw (2).

