

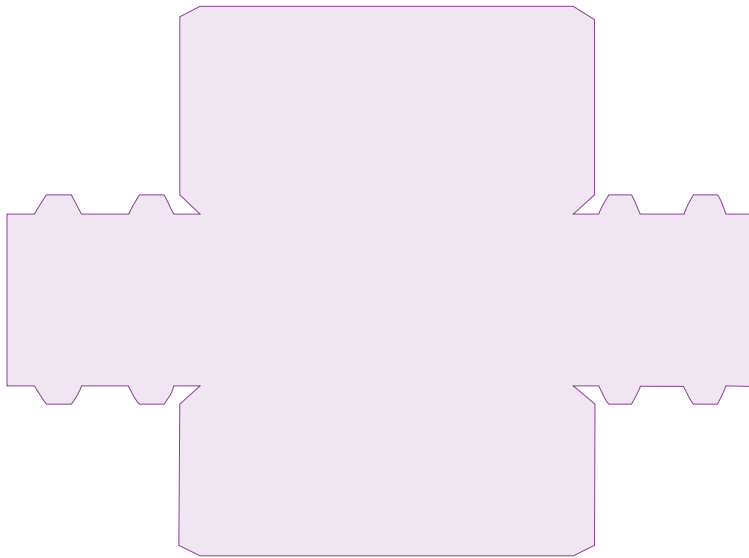

Paper Folding Basket

Here's What You Get!



1 Base

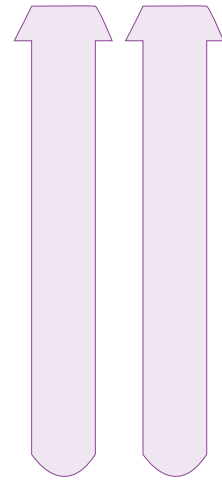

2 Handles

1. Fold in all the edges and tabs.

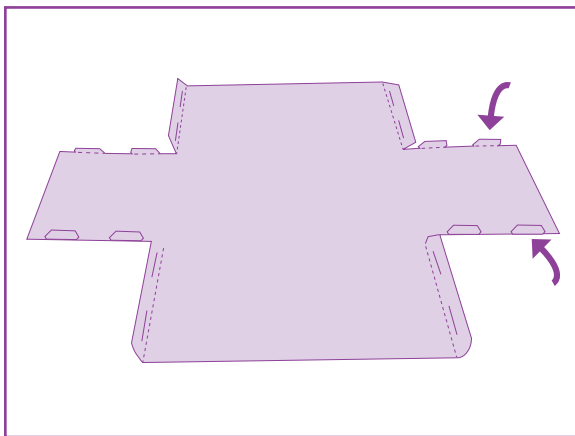

Figure 1

2. Fold up all four sides and insert tabs into slits to lock.

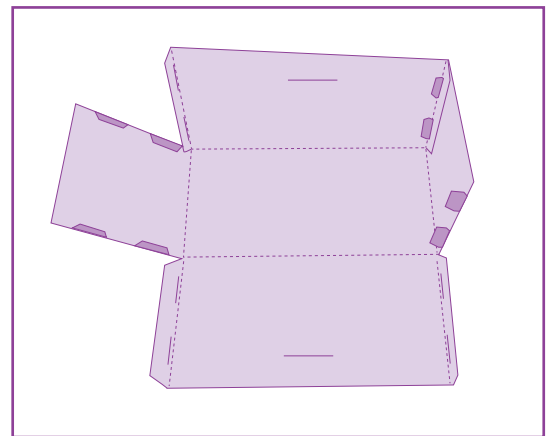

Figure 2

Paper Folding Basket (continued)

3. Repeat step 2.

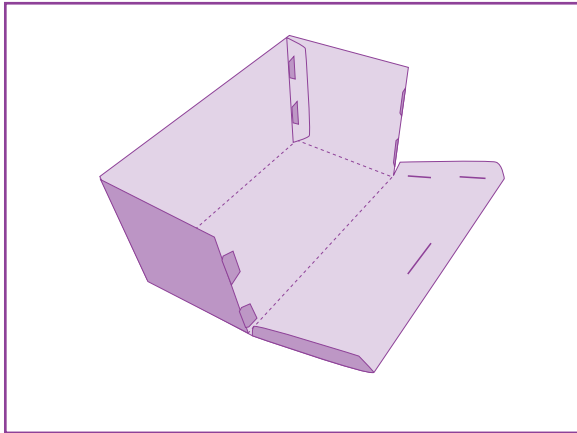

Figure 3

4. Insert the "T" ends of both long strips into the slits shown.

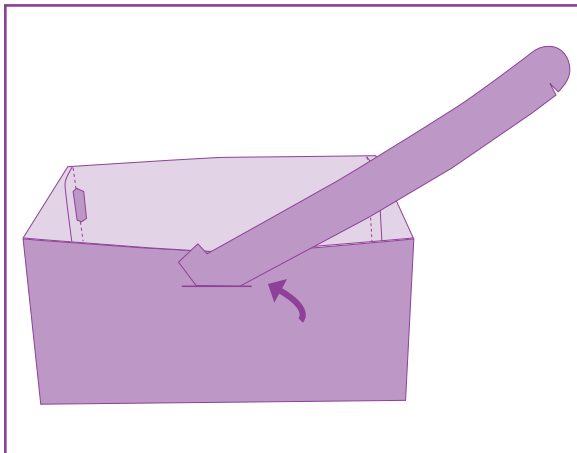

Figure 4

5. Connect the round ends of the long strips at the top.

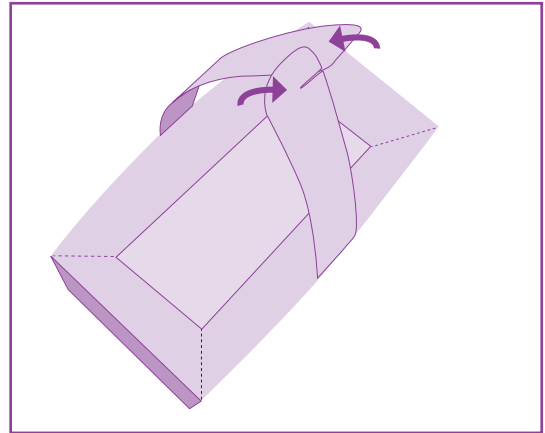

Figure 5

6. Finished.

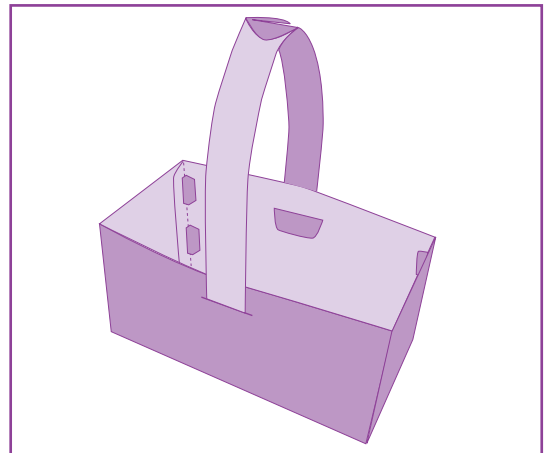

Figure 6