

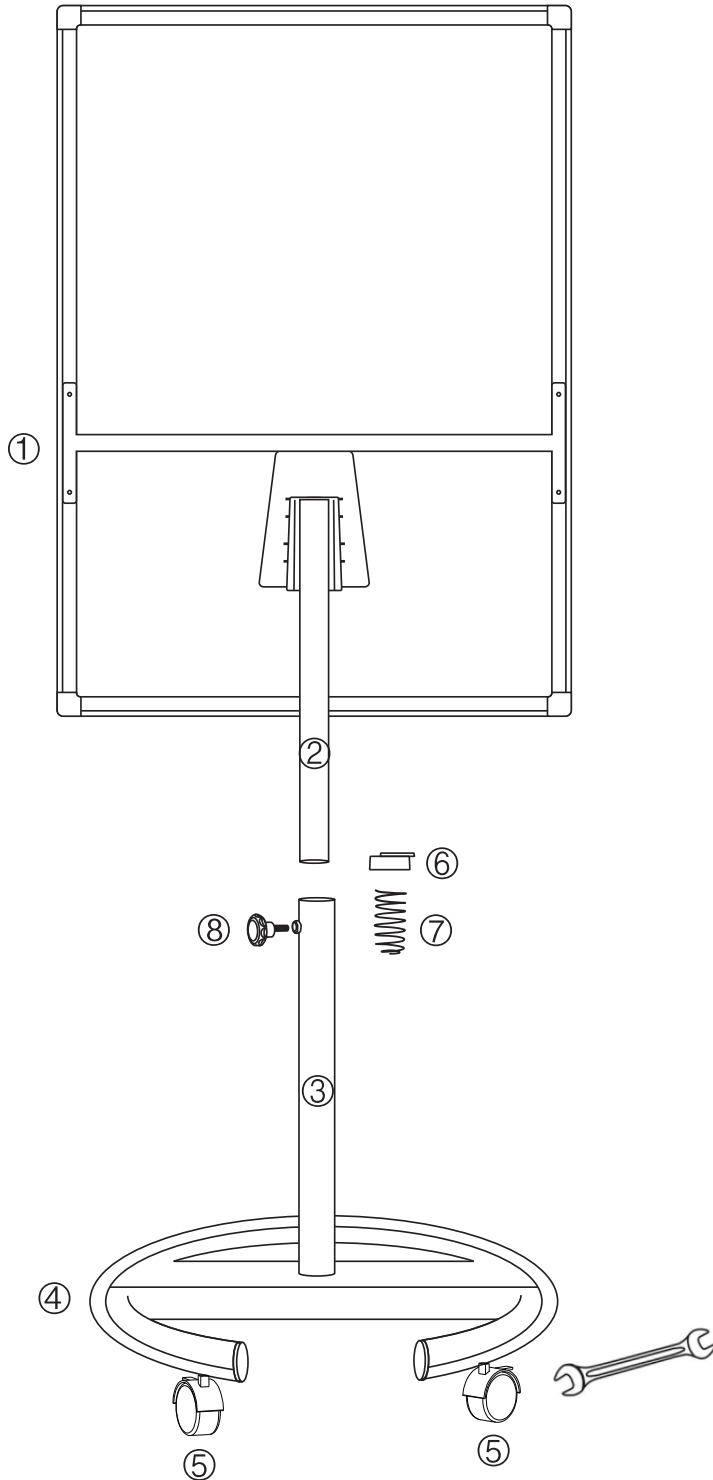

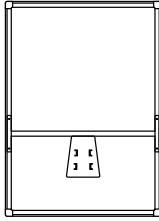

# Adjustable Magnetic Dry Erase Easel Assembly Instructions

Congratulations on your purchase of this **Adjustable Magnetic Dry Erase Easel**. (Adult assembly required.)

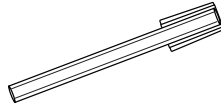
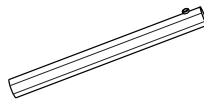
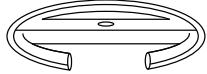

## PARTS LIST

Description		QTY.
①	 Whiteboard	1
②	 Upper column	1
③	 Lower column	1
④	 Pedestal	1
⑤	 Castor	5
⑥	 Cap	1
⑦	 Spring	1
⑧	 Setting knob	1

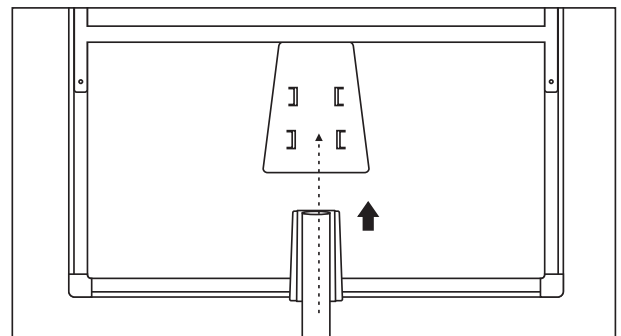

All instructional guides can be found online.